

Article number: 2310308105ESD

Description: E+G Antistatic base for levelling elements
LV.A-70-14-AS-M16x108-ESD-C

Measures

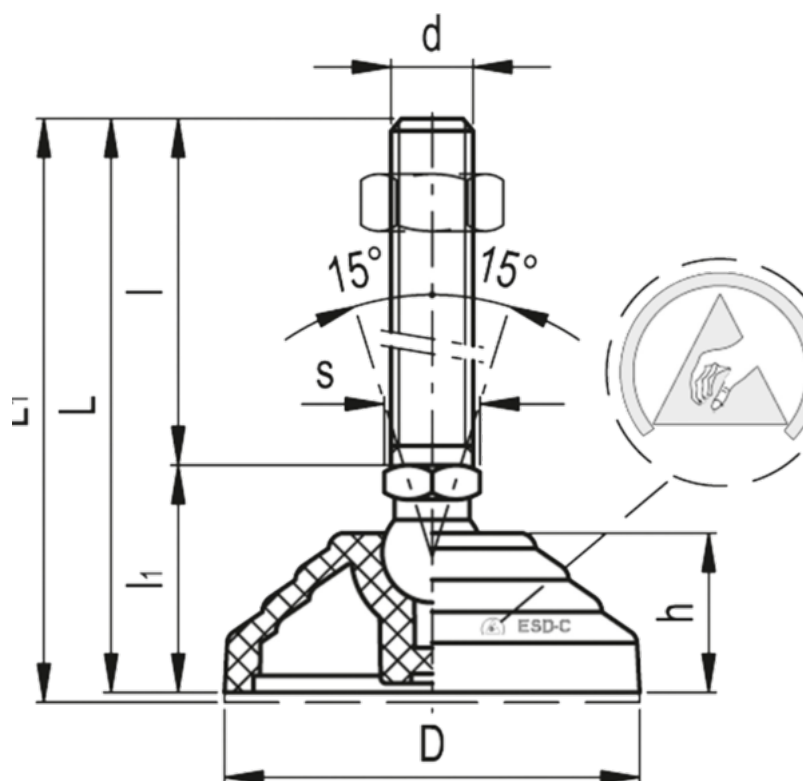

Articulation	= 14	Max load	= 14000
D	= 70	s	= 16
d	= M16	Weight in (g)	= 212
h	= 19		
l	= 108		
L1	= 28		
L	= 136		
L1	= 139		